



Image for demonstration purposes

Generating Set
Base Frame - Diesel

GE.PK.500/450.BF+011

1500 rpm - Threephase - 50Hz - 400V
 Automatic panel without switching on board



Standard equipment

Exhaust

Exhaust manifold protection
 Silenced muffler -15dB(A)

Fuel Supply

Single wall daily tank with bunded base
 Automatic shutdown system for low fuel level
 Fuel gauge

Handling

n.4 lifting hooks integrated into the bearing structure

Base Frame

Bunded base at 110% of fuel tank capacity
 Anti-vibrating mounting pads

Engine

High coolant temperature and low oil pressure shutdown system
 Oil pressure and coolant temperature gauge (only with QPE or +14 variant)
 External oil drain points
 Engine liquids (oil and antifreeze)
 Tropicalized radiator
 Rotating parts protection
 Electronic speed governor
 Radiator level sensor

Alternator

AVR Automatic Voltage Regulator
 AVR Pre-arranged for parallel
 Impregnation for marine environment
 IP23

Panel & connection

Emergency Stop button
 Magnetothermal circuit breaker on alternator board
 Cable output from side
 IP44 wiring
 Start-up battery (pre-charged)
 Grounding point

Documentation

CE conformity declaration
 User and Maintenance manual
 Wirings diagrams

Normatives

All Generating sets are compliant to CE Marking
 2014/30/UE Electromagnetic compatibility
 2000/14/CE Noise Emission for outdoor use
 Factory-designed systems built according to ISO 9001:2015
 CEI EN 60204-1:2018 - Electrical equipment of machines

Primary data

General Information

Speed	RPM	1500
Frequency	Hz	50
PRP	KVA	455
PRP - Prime power	KW	364,0
LTP - Standby power	KVA	500
LTP - Standby power	KW	400,0
Standard Voltage	V	400/230
Current	A	657,51
Voltage for current calculation	V	400
COSFI	0,8	0,8

General electrical protection

Circuit-breaker rated current	A	800
Type	Magnetothermal switch on the alternator board	
Circuit-breaker poles	N	4P

Fuel Consumption

TYPE		Diesel
Standard Fuel Tank capacity	lt	400
Autonomy @ 75% load	h	6
Fuel consumption at 100% load	lt/h	99
Fuel consumption at 75% load	lt/h	73
Fuel consumption at 50% load	lt/h	51

General data

Rated capacity	Ah	2x180
Auxiliary Voltage	V	24
Exhaust gas temperature	°C	550
Exhaust gas flow	l/s	1416
Combustion air flow	l/s	550
Cooling fan airflow	mc/s	12
Exhaust diameter	mm	120

Weight and Dimensions

Dimensions (L x w x h)	cm	350x150x197
Weight with liquids (excluding optionals and fuel)	Kg (+/-3%)	3740

Engine

Factory		Perkins
Model		2506A-E15TAG1
Emissions stage		Stage 0
Speed governor		Electronic
Radiator	°C	50
Cooling	Tipo	liquid (water + 50% Paraflu11)
Active net power	Kwm	396
Nominal net power	CV	538
Cycle	Tipo	4 strokes
Injection	Tipo	Direct
Aspiration	Tipo	Turbo
Numbers of cylinders	N	6
Cylinders arrangement		L
Bore	mm	137
Stroke	mm	171
Total displacement	lt	15,117
Engine oil features		15W40-API CI-4/CH-4 ACEA E5-E7
Total oil capacity	lt	62
Total coolant capacity	lt	58
ISO 8528-5 class		G3

The emission levels of the exhaust gas are indicated in the engine technical datasheet. Any changes due to more restrictive regulatory adjustments are excluded.

Alternator

* May vary based on stock availability. However, a primary brand will be used.

Factory		Stamford
Model		S4L1D-G
Single-phase Range	KVA	450
Voltage Regulator (voltage accuracy)	+/- %	1
Poles	N°	4
Phases	N°	3+N
Standard windings connection		Star Series
Stator/rotor impregnation		H (Outdoor Temp 40°C)
Efficiency	%	93,3
Engine coupling		Elastic disk
Short circuit current		>= 300% (3In)
Protection degree	IP	23
Cooling system		Self ventilating
Maxium overspeed	rpm	2250
Waveform distortion	%	<5
Exciter		Diode bridge

Standard operating environmental conditions

Ambient temperature	°C	25
Relative Humidity	%	30
Max altitude	mt	1000

Control Systems on board QPE-C-SC-3F-V1

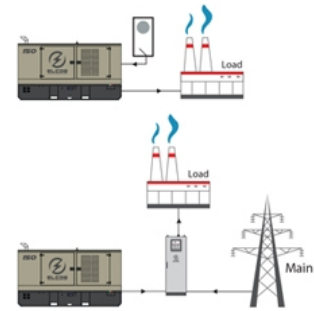

operating scheme - schema di funzionamento

QPE Automatic panel without switching on board

The QPE-C control panel represents the evolution of the panel for the control and management of the gen set. With its microprocessor logic it is able to meet any user requested features. The dual operation mode manual and automatic guarantees to every type of functionality protection, analysis and control of the generating set in order to make the management easy and efficient. Variant without transfer switch on board. ATS panel type QC as optional. The panel manages the QC panels directly or any other ATS panel.

Mechanical features

Protection degree	IP	55
-------------------	----	----

Battery charger

Model		ELCOS - CB1
Maximum output current	A	2,5
Output DC voltage (selectable)	Vdc	12-24
Input AC voltage (selectable)	Vac	220-260
Frequency	Hz	50-60

Data Communication

Data connection port	RS-485
Communication protocol	Mod-bus RTU-8N1

Remotable functions in terminal box

GS start	GS lock
Genset contactor close/open command (1)	Mains contactor close/open command (2)
Common Alarm - DC output	GS test without load
GS start with key in OFF position (Only in MRS mode)	Programmable output - Volt free output

Control Module



Model	MC4
Operating mode	AMF - MRS

Specifics

Applications

Emergency to the Mains
Stand-alone
Construction site/Rental
Self-production

ENGINE MEASURES

Fuel tank level %
Engine oil pressure BAR (1)
Engine Coolant temperature °C (1)
Total run time
Partial run time
Hours to maintenance
Battery voltage
Battery charging voltage
Start-ups counter
Engine speed (2)
Engine Oil temperature (2)
Cooler temperature (2)
Engine oil level (2)
Engine coolant level (2)
Engine coolant pressure (2)
Turbo pressure (2)
Fuel Consumption (2)
Tank autonomy - hrs (5)
Fuel remaining quantity (5)
Fuel used quantity (5)

ALTERNATOR MEASURES

Generator Voltage L1, L2, L3
Generator Voltage L1-N, L2-N, L3-N
Generator frequency
Generator current L1, L2, L3
Generator Apparent Power kVA
Generator Active Power kW
Generator Reactive Power kVAR
Generator accumulated power kWh
Power factor Cosφ

MAINS MEASURES

Mains voltage L1, L2, L3
Mains voltage L1-N, L2-N, L3-N
Mains frequency

COMMUNICATION PORTS

Can-bus port
RS485 port with Mod-bus RTU communication
RS232 port for display connection
USB port for parameters saving and firmware update

EQUIPMENT

Microprocessor Logic
Back-lit display
Programmable from display
16 event log
Multiple display languages
STOP button
START button
TEST button
Reset alarm button
Alarm mute button
Fuel transfer pump activation button
Glow-plug activation button

PRE-ALARMS/ ALARMS

Common Alarm
Fuel reserve (pre-alarm)
Low fuel level (alarm)
Tank overflow
Charge alternator failed (dinamo)
Low oil pressure (pre-alarm) (1)
Low oil pressure (alarm)
Oil sensor failed (alarm)
High coolant temperature (pre-alarm) (1)
High coolant temperature (alarm)
Low coolant temperature (pre-alarm)
Low water level (1)
Water in fuel (1)
Battery undervoltage
Battery overvoltage
GS failure to start
GS failure to stop
Can-bus Failure
No Can-bus communication
Genset overload L1, L2, L3 phases
Genset short circuit
Genset overvoltage
Genset undervoltage
Genset high frequency
Genset low frequency
overspeed
Reverse power
Earth fault (pre-alarm)
Earth fault (alarm)
Block from password
CAN communication Failed
Maintenance request
Emergency button pressed
Remote emergency active
Forced stop
External battery failed
Fuel theft
Genset negative phase sequence
Mains negative phase sequence
Fuel theft protection

VISUALIZATIONS ON CONTROL MODULE/DISPLAY

Pre-alarms
Alarms
Engine measures
Alternator measures
Mains measures
Date and time
Operating mode
Genset status
Mains status
Mains contactor status
Genset contactor status
Digital Input and Output status
Grounding current mA (3)
Grounding current threshold mA (3)
Delay time of differential protection (3)
Glow plugs status

CONTROL MODULE FUNCTIONS

Automatic start and stop when the Mains Fails (7)
Remote Start and Stop
Remote Start and Stop with key in OFF position
Manual Start and stop
Emergency stop button on panel board
Remote emergency stop
Remote lock
Remote test without load
Remote test on load
Scheduled start-ups
MODBUS commands (Start, Stop, Reset, Test)

CONTROL MODULE SPECIAL FUNCTIONS (on demand)







Automatic charging of an external battery
Dummy load (4)
Load shedding (4)
Redundant starter motor management
Fuel monitoring
GS battery Load test
Idle mode
Service phone number indication
Variable speed Generator
Master / Slave mode

- (1) Present with the sensor installed on engine
(2) Present according to the engine equipment and to the ECU type (ECU - Canbus)
(3) Present only with the residual current device mounted on genset board
(4) Present with optional expansion modules
(5) Present with special function activated
(6) Only with the optional of the automatic fuel refilling system on board
(7) Only in AMF mode







AAABBB

OPTIONAL

Fuel Supply

	O.G-ACO-AT-C3V-02	External fuel tank connections with 3-way valve for supply from internal or external tank (130/700 kVA)
	O.G-ACO-AT-CI-02	External tank connections for supply only from external tank (g without tank) GE 130/700
	O.G-ACO-BT-B3500-1000	1000 Lt Oversized Fuel Tank on board for BF (450/700 kVA), (Increased weight and size)
	O.G-ACO-BT-B3500-2000	2000 Lt Oversized Fuel Tank on board for BF (450/700 kVA), (Increased weight and size)
	O.G-ACO-GA-01	Mechanical analogue float for internal fuel tank on board
	O.G-ACO-ST-2P	Double redundant electric pump kit for automatic fuel refilling system
	O.G-ACO-ST-BG-ES1	"Easy" automatic fuel refilling system on board, controlled by QPE-C and QLE-B panels
	O.G-ACO-ST-BG-HDT	"Heavy Duty" automatic fuel refilling system on board, controlled by QPE-C and QLE-B panels
	O.G-ACO-ST-BG-STD	"Standard" automatic fuel refilling system on board, controlled by QPE-C and QLE-B panels

Alternator

	O.G-ALT-AL-CHBR-05	Different brand alternator 450/700 kVA (Check dimensions)
	O.G-ALT-AL-COTE-01	Temperature control unit up to 4 x PT100 probes for MC4 management
	O.G-ALT-AL-GEL-04	Joint and bell housing for double-bearing coupling (BF Gen Sets 450/700 kVA)
	O.G-ALT-ST-ACO-01	Anti-condensation heater 230 V (on Stamford from 80 to 2000 kVA)
	O.G-ALT-ST-AVR-MX321	Stamford MX321 automatic voltage regulator with PMG (Check dimensions)
	O.G-ALT-ST-AVR-MX341	Stamford MX341 automatic voltage regulator with PMG (Check dimensions)
	O.G-ALT-ST-BIS-01	Additional cost for double-bearing alternator (select also joint and bell housing code) from 130/700 kVA
	O.G-ALT-ST-PT100-1CU	1 x PT100 probe on bearing (80/3000 kVA)

ЭНЕРГОКОНТИНЕНТ

O.G-ALT-ST-PT100-3AV

nr. 3 RTD-PT100 probes on stator windings (80/3000 kVA)

O.G-ALT-ST-PT100-6AV

nr. 3+3 RTD-PT100 probes on stator windings (80/3000 kVA)

O.G-ALT-ST-RIGU-01

Diode Failure Detector (DFD) mounted on the alternator. Alarm contact available into the panel

 **Batteries**

O.G-BAT-BAE-05

Maintenance free high efficiency starter batteries (450/700 kVA)

O.G-BAT-BNC-05

24Vdc NiCd starter batteries (450/700 kVA)

O.G-BAT-DOB-04

Redundant battery kit for Gen Sets 450/700 kVA

O.G-BAT-STB-02

Battery isolator lockable(130/700 kVA)

 **Container**

CONTAINER-20-LT-01

Insulated Container 20' - LT Version - Standard GREY RAL 7015, Dim. cm. 606 x 244 x 259H - (450/700 KVA BF version)

CONTAINER-20HC-55D-01

Soundproofed Container 20' HC - Standard GREY RAL 7015, acoustic isolation 55 dBA at 7mt. (+/-3). Dim. cm. 606 x 244 x 289H - (450/700 KVA BF version)

CONTAINER-20HC-65D-01

Soundproofed Container 20' HC - Standard GREY RAL 7015, acoustic isolation 65 dBA at 7mt. (+/-3). Dim. cm. 606 x 244 x 289H - (450/700 KVA BF version)

CONTAINER-20HC-75D-01

Soundproofed Container 20' HC - Standard GREY RAL 7015, acoustic isolation 75 dBA at 7mt. (+/-3). Dim. cm. 606 x 244 x 289H - (450/ KVA BF version)

 **Electrical on board**
O.G-USP-SW-MOT.0450-0700

Motorization switch in switch panel on board machine for Ge from 450/700 Kva - (for variant +11)

O.Q-QBM-BMIN-230V-02

Additional price for 230V minimum voltage coil on MCCB both on the control panel and on the alternator (check feasibility)

O.Q-QBM-CPI-BEN-01

Permanent insulation controller for IT networks up to 230V / 400V. BENDER IR423-D4-1. Adjustable threshold 10 ÷ 300 kohm. (2 DIN rail modules - check feasibility)

O.Q-QLE-K-DIF-M3

Adjustable differential protection only for MC2-PLUS controller for Gen Sets 10/500 kVA (+011 variant)

O.Q-QPE-485.CONV-LAN

Converter 485/LAN for QPE-C, QLE-B panel

	O.Q-QPE-485.CONV-USB	Converter 485/USB for QPE panel
	O.Q-QPE-DIS-MS.01	MASTER/SLAVE device for QPE panel
	O.Q-QPE-INT-CST-CTR-03	STATUS and TRIP contact of main breaker wired to terminal board inside the QPE panel (275 / 1000KVA) on board (not for variant +010).
	O.Q-QPE-K-DIF	Differential protection adjustable for the MC4
	O.Q-QPE-MD-QPE-C	GSM remote management modem for QPE panel
	O.Q-QPE-POT-VOLT	Internal potentiometer for voltage regulation - available only for variant +10/+11
	O.Q-QPE-PR-QPE-C	Remote panel for QPE-C, QLE-B - available only for variant +10/+11
	O.Q-QPE-QBM-COM-AMF25	Option with QBM COMAP AMF25 controller on board instead of QPE
	O.Q-QPE-QBM-DSE-7320	Option with QBM DSE7320 controller on board instead of QPE.
	O.Q-QPE-RIL-16RELE	16-relay module for QPE panel
	O.Q-QPE-RX8-QPE-C	Start-stop radio control with max. radius 500 mt indoors and 5 km outdoors (for QPE panel).
	O.Q-QPE-SAS-02	Auto Start-Stop at load request (QPE, QLE panels)
	O.Q-QPE-SCD-01	Anti-condensation heater inside the panel
	O.Q-QPE-SEL-50-60	Switch selector 50Hz 400V / 60Hz 480V
	O.Q-QPE-TG-EVO-GPS-2G	Remote management system via LAN/GSM 2G with WEB application and GPS location system
	O.Q-QPE-TG-EVO-GPS-3G	Remote management system via LAN/GSM 3G with WEB application and GPS location system
	O.Q-QPE-TG-QPE-C	Remote management software via LAN for QPE-C, QLE-B panel compatible with Windows XP and 7
	Engine	
	O.G-MOT-FC-8	Dust collector filter - for Gen Sets 450/600 kVA

энергоконтинент

Data and technical specifications are subject to change in order to update or improve the products.

	O.G-MOT-FSA-8	Fuel/Water Separator Filter - for Gen Sets 450/600 kVA
	O.G-MOT-K-40C-05	Engine liquids suitable for -40°C ambient temperature for Gen Sets 450/700 kVA
	O.G-MOT-MAG-04	Dual starter motor for Gen Sets 450/700 kVA (engine configuration to be checked)
	O.G-MOT-PO-02	Oil change pump for Gen Sets 130/700 kVA
	O.G-MOT-SC-AC-EL-04	Super hot engine heater 230V with thermostat on board for Gen Sets 275/700 kVA
	O.G-MOT-SC-AC-WE-03	Webasto diesel-operated water pre-heater (450/1100 kVA)
	O.G-MOT-SE-LR-02	Radiator coolant level sensor from 130 to 700 kVA
	O.G-MOT-SRO-AU-50L	Automatic oil refilling system (275/700 kVA)
 Handling		
	O.G-MOV-GC-BF-3500	Central Lifting hook (450/700 kVA) BF Version
 ATS Panels		
	QC2.0800A	Separate ATS panel, ABB 800A motorized change-over (500 kVA 400V) Dim. 60 x 50 x 160 cm - 128 kg. (ex QC2.550)
	QCP2.0800A	Separate ATS switching panel, with Lovato ATL 610 control unit, for variant +014, ABB motorized change-over 800A 4P (500kva 400V) and compartment for power cables inlet
 Parallel panels		
	QP.APM3.0800A	APM Automatic Parallel Module Comap IntelliVision5 logic with motorized breaker (800A) for gen set from 300kVA to 550kVA. Dim. cm. 60 x 60 x 190H.
 Exhaust		
	O.G-SCA-CAT-07	Catalytic converter (450/550 kVA)
	O.G-SCA-FAP-K500	Particulate filter (DPF) for Gen Sets 450/500 kVA
	O.G-SCA-GF-120	Exhaust bellow with flexible joint including flange and counter flange (275/700 kVA)

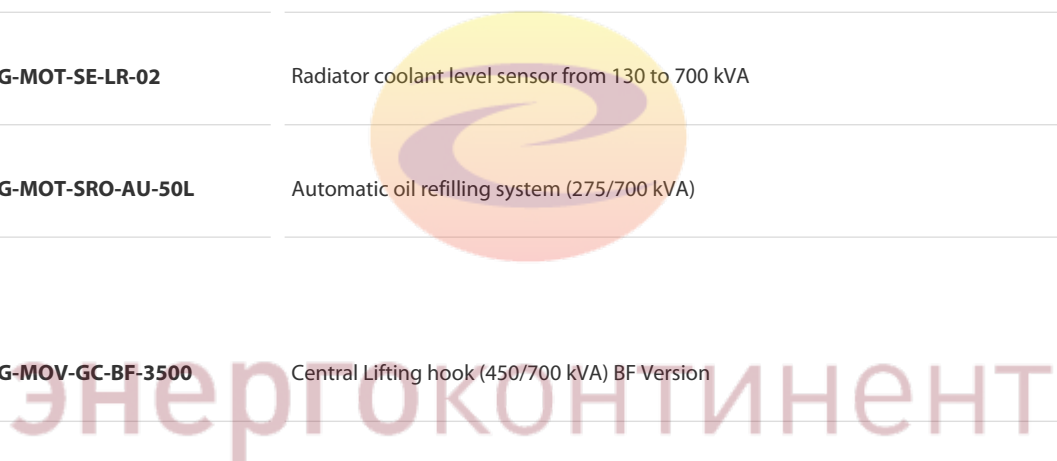



O.G-SCA-MR-07

Residential muffler -35 dBA (450/700 kVA)

O.G-SCA-MR-MO-03

Installation on board for residential muffler, particulate filter, catalytic converter on BF (450/700 kVA)



O.G-SCA-PF-05

Spark arrester for Gen Sets 450/700 kVA

 **Test**

MS.CP-LT-03

FAT - Factory Acceptance Test for single Gen Set from 450 to 700 kVA according to our standard procedures in Elcos factory (max 2 hours - max 4 people - max 1 hour of operation)

MS.CP-SP-03

FAT - Factory Acceptance Test for single custom Gen Set from 450 to 700 kVA max 4 operating hours or parallel system up to 4 units for 1 operating hour, in Elcos factory (max 4 hours - max 4 people)



MS.CP-ST-03

FAT - Factory Acceptance Test for single Gen Set from 450 to 700 kVA according to our standard procedures in Elcos factory (max 4 hours - max 4 people - max 2 hour of operation)



MS.TV-ST-02

Vibration test on 10 points with certificate for single Gen Set from 275 to 3000 kVA

 **Vari**



O.G-VAR-CAT-02

Toolbox for ordinary maintenance.

O.G-VAR-PUN-TER-01

Round earth spike, diam. 20 mm, height 1.5mt, galvanized, complete with clamp and 3m yellow/green cable model FS17 1x35mm² with cable lugs.

O.G-VAR-PUN-TER-02

Cross-shaped earth spike, height 1.5mt, galvanized, complete with clamp and 3m yellow/green cable model FS17 1x35mm² with cable lugs.



O.G-VAR-SFA-06

Aspiration / expulsion sound attenuators -25dBA for Gen Sets 450/700 kVA BF Version

PRP

Engines of this rating provide unlimited hours of usage in a variable load application. The average load factor should not exceed 70% of the engine's prime power rating with a maximum number of 500 operational hours at 100% prime power rating. An overload capability of 10% is available, however, is limited to a period of 1 in every 12 hours

LTP

Limited-time running power is defined as the maximum power available, under the agreed operating conditions, for which the generating set is capable of delivering for up to 500h of operation per year with the maintenance intervals. The overload is not allowed.

Sheet:	B3500	OPEN FRAME	Exhaust side:	Type:	STANDARD	Rev:	00	Last Update:	Mar 20, 2019	Page 1/2
--------	-------	------------	---------------	-------	----------	------	----	--------------	--------------	----------

OVERALL DIMENSIONS [mm]

REAR VIEW

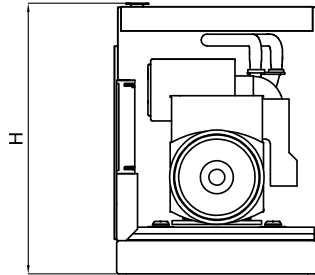

LEFT SIDE VIEW

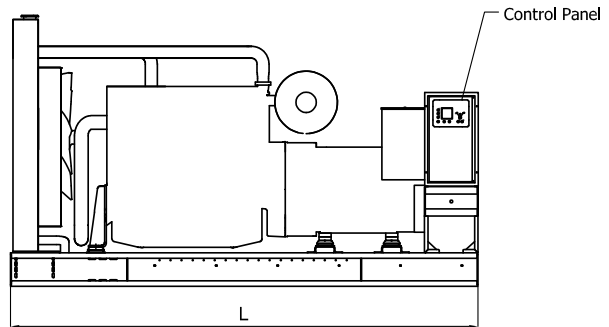

FRONT VIEW

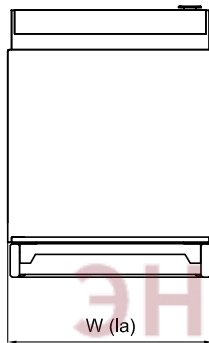

RIGHT SIDE VIEW

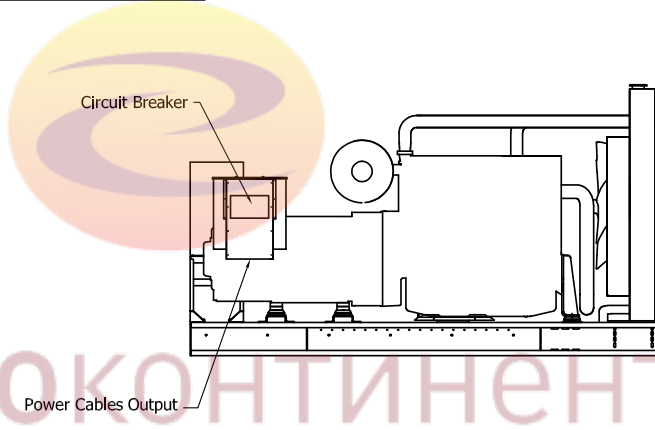

TOP VIEW

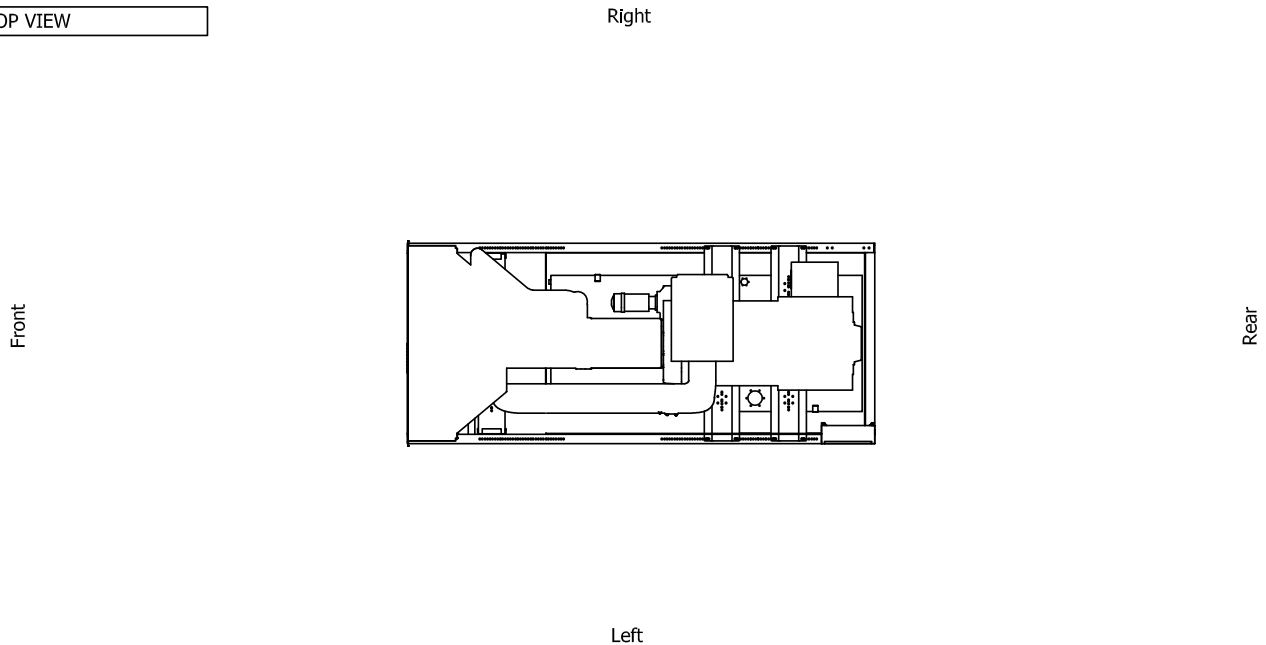

IMPORTANT:

- 1) Form and dimension refer to the generating set on catalogue
- 2) Form and dimension are subject to change in order to update or improve the products
- 3) This document can not be copied or transmitted without ELCOS S.r.l. approval

Sheet: B3500	OPEN FRAME	Exhaust side:	Type: STANDARD	Rev: 00	Last Update: Mar 20, 2019	Page 2/2
--------------	------------	---------------	----------------	---------	---------------------------	----------

BOTTOM VIEW

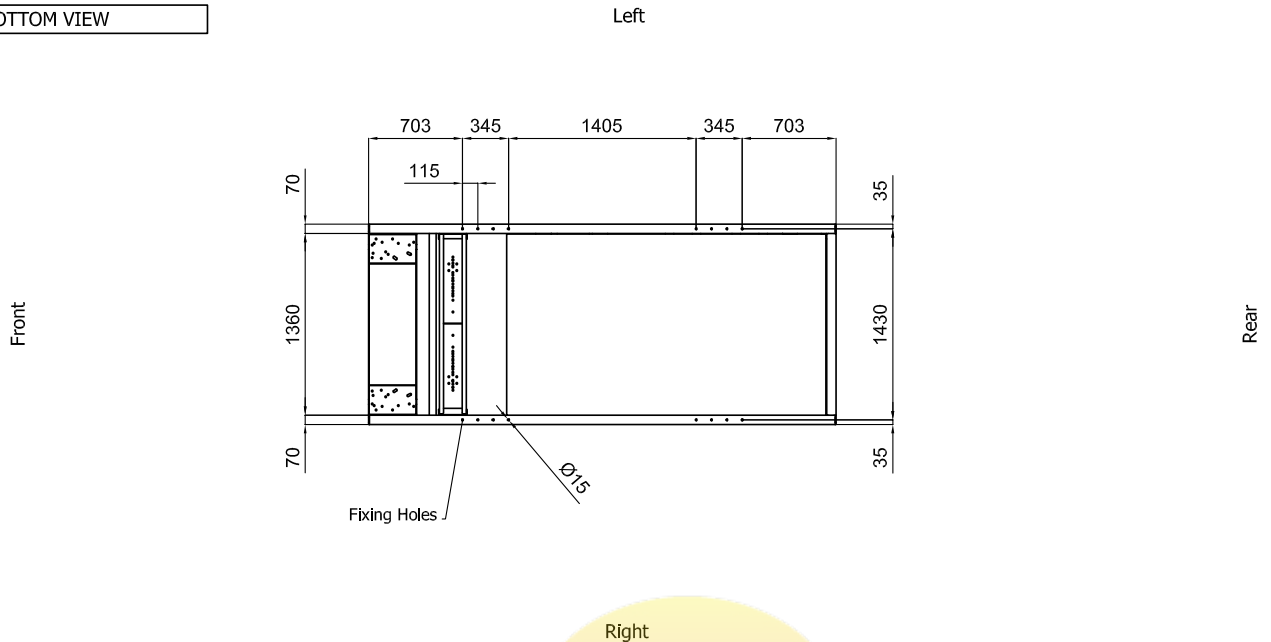

DIMENSIONS WITH OPEN DOORS [mm]

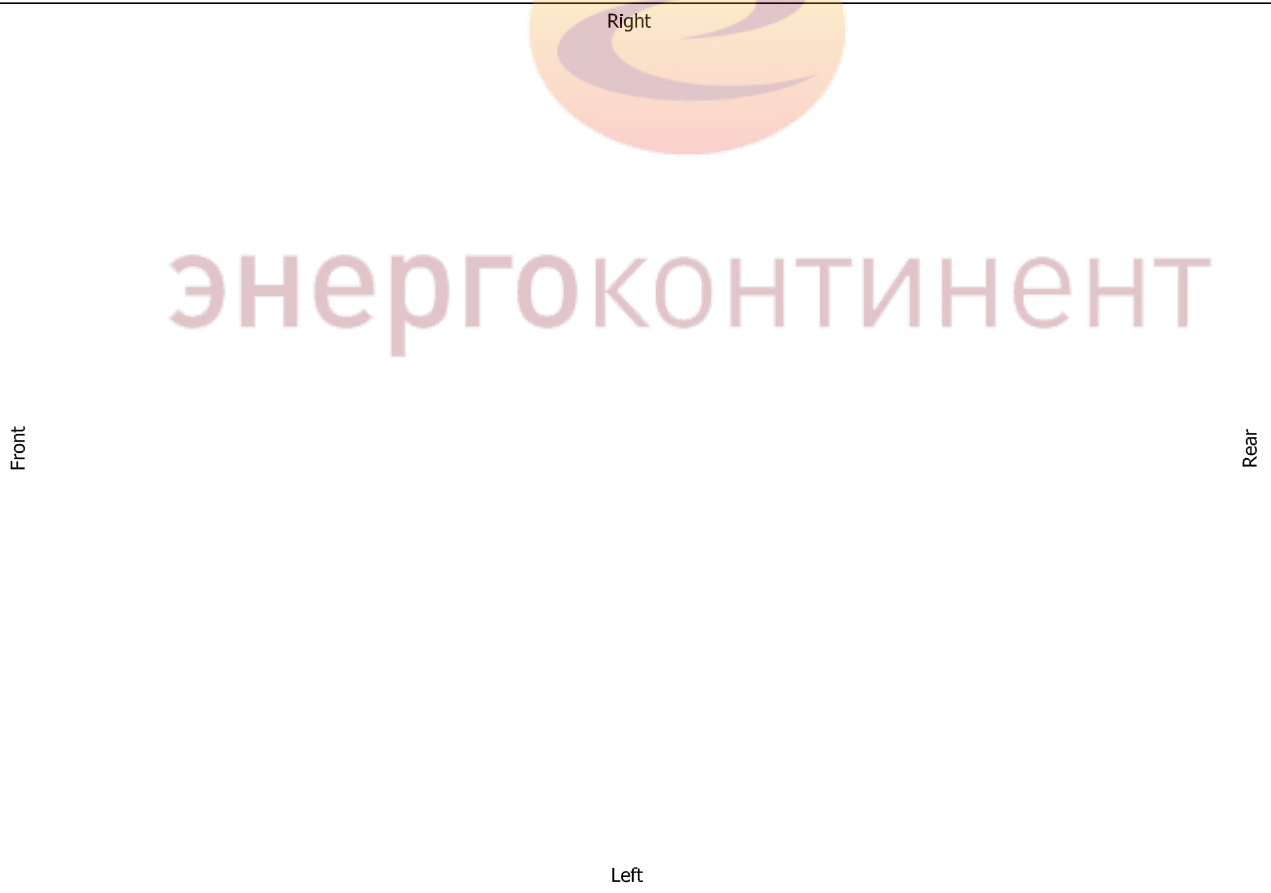

VENTILATION OF THE ROOM

The windows area in the generating set room needs to be (recommended):
 Aspiration: on request
 Expulsion: on request
ATTENTION: for a correct ventilation the expulsion air and the exaust gas needs to be conveyed in the open-air

IMPORTANT:

- 1) Form and dimension refer to the generating set on catalogue
- 2) Form and dimension are subject to change in order to update or improve the products
- 3) This document can not be copied or trasmitted without ELCOS S.r.l. approval